

AME0001

## Design and testing of wing assembly function for a small unmanned aerial vehicle aircraft

Limsumalee Nattawan <sup>1</sup>, Sripawadkul Vis <sup>2</sup>, and Thipyopas Chinnapat <sup>3</sup>

Department of Aerospace Engineering  
Faculty of Engineering, Kasetsart University

E-mail: [mickey.bow.me@gmail.com](mailto:mickey.bow.me@gmail.com) <sup>1</sup>, [fengvisp@ku.ac.th](mailto:fengvisp@ku.ac.th) <sup>2</sup>, [fengcpt@ku.ac.th](mailto:fengcpt@ku.ac.th) <sup>3</sup>, Tel: +66-81-714-6189

### Abstract

This research was interested in wing assembly function of a small unmanned aerial vehicle aircraft. The disassembly of the mechanical locking device was studied. The objective of this research is to design mechanical locking device that can absorb the force applied on the structure of aircraft and can be quickly, easily disassembled to save time and space for transportation and did not fail during the wing testing and operation flight. This small UAV has 2 meters of span and 4 kilograms total weight with 3 locations of mechanical locking devices, 2 points at the wing, 1 point at the fuselage, and 2 points at the tail. Then applied forces by giving a load factor of 2.5 to weight onto the wing for wing testing. The results showed a slight bending at the wing without damaging wing's structure and locking devices. In conclusion, material and structure of the locking device is the primary keys to future development in order to construct a higher performance and more efficient locking mechanism.

**Keywords:** Small unmanned aerial vehicle, Mechanical locking devices, Wing testing, Wing assembly function.

### 1. Introduction

Unmanned Aerial Vehicle (UAV) is now widely used both for military and civil sectors. Generally UAVs have different sizes, shape and design depending on usability. This research focus on a small unmanned aerial vehicle aircraft (small UAVs) carrying 500g camera for mapping mission that must be easily transported. The size of UAV for this mission is approximately 1.50-2.00m wing span. Therefore, the development to disassembling mechanism of small UAVs are popular. In this research, locking mechanism was designed to disassembling easier for operations by carrying. The design of this small unmanned aircraft is saving a space for storage and has facilitating for portable functions so the removable wing is designed. The fuselage and tail were designed to ease for assembly.

### 2. Prototype Design

This research studied about the force that apply to Luck#1799 aircraft, which is a small unmanned aerial vehicle that was researched to enhance more facility and portability for disassembling. The main purpose is to make it easier to operate flights and perform a variety of applications, such as 3D maps, agricultural operations and telecommunications. Luck#1799 was initially developed from design requirement of geomatics engineering from Kasetsart University who has required to use UAV which has the following requirements: The mission is survey and mapping for aerial photography. The wing span has a length of 200 centimeters measured from the tip of one to the other side wing tip. The width of fuselage for carrying payload is 11 centimeters. The payload is about 500 grams which consist of camera. The maximum length

of time to operated flight is one hour. Thus cause disadvantages of other aircraft such as, cannot put the camera in a horizontal line because there is not enough space for the payload (camera), disassembly design is not good enough which may cause accidents and falls, or weight is too inappropriate to the size of the aircraft. Therefore, Luck#1799 was designed to correct the disadvantages and improved the requirement. After that, Luck#1799 was amended to increase the assembly function and force testing in order to apply a mission then became to Cholly#1 that used in this research. Cholly#1 detail design is in the following.

Starting from the estimation of weight that the total weight of the aircraft is about 4 kilograms while configured stall speed to 8 m/s. Then enter the formula into the calculation table in Microsoft Excel, based on aircraft design of Michael N.C. (1988) [3]. After that, selected airfoils of wing and tail from Cl/Cd graphs which provide the minimum value of Cd and the maximum value of Cl/Cd. Due to the above theory and experience, NACA 6409 were chosen for wing's airfoil and NACA 0009 were chosen for the part of the tail that is a symmetrical airfoil which are suitable for horizontal and vertical tail because it can control the turning and pressing or rolling of the aircraft. Then analyzing the aerodynamic coefficient by vary the angle of attack from -2 to 11 degrees while the required speed was 12 meter per second and set the above values into XFLR5. From graphs as shown in Fig.1, the prototype aircraft has CL about 0.6 and Cm equal to 0 when the angle of attack was 0 degree which indicated that the prototype has good stability because the slope of Cm per Alpha is negative.

## AME0001

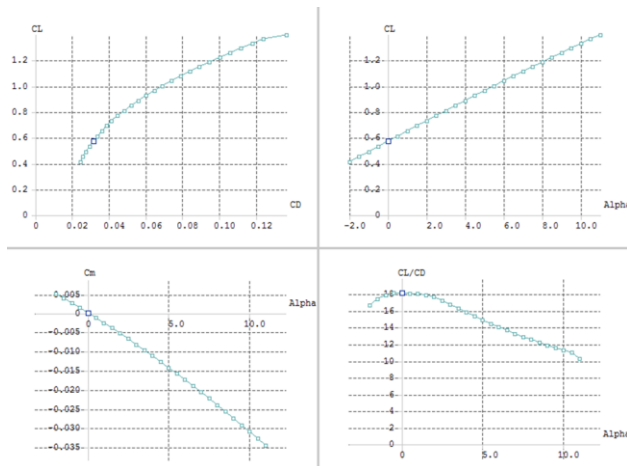

**Figure 1. The aerodynamic coefficient's graphs of prototype.**

When analyzed by the program XFLR5, The prototype has the size as shown in Fig.2.

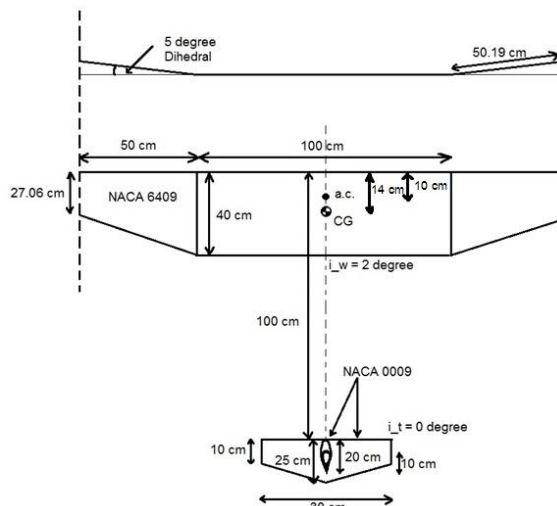

**Figure 2. Top view sizing of Cholly#1.**

And detail of the prototype as shown in Table 1 was used to calculate the force in the next step.

**Table 1: Detail of the prototype in Fig.2.**

Parameter	Values
Semi span (b)	2 m
Chord root	0.4 m
Chord tip	0.2706 m
Semi wing structure weight	0.5045 kg
Inner wing structure weight	0.2777 kg
Outer wing structure weight	0.2268 kg
Total weight	4.054 kg
C.G. position (X-axis)	0.14 m
C.G. (% MAC)	37.5 %
a.c. (% MAC)	27 %

To operate the flight missions, prototype is made into many part because disassembly and conveniently was needed. Therefore, forces that occurred at the wing had to calculated, which will be used to design and test locking devices to disassemble the wing.

### 3. Force analysis for mechanism design

This research studied the force by presenting just three areas, 2 points at the wing, 1 point at the fuselage and 2 points at the tail. Especially in the wing area, it can be disassembled to three part so when the wing is removable [1], the length of the wing reduce to only 75 centimeters. At 2 points on the wing have mechanical locking devices that each point has two types of force, shear force and moment. At first the force of the total weight and lift force that will occur during the flight was calculated. Therefore, it was calculated on the assumption that lift is equal to 4 kilograms as all of the total weight. Then wing shear is found from the relationship of weight and distance along the length of the wing [4]. Also the forces that occur at the base of the wing was found as the vertical shear 2.028 kilograms and wing bending moment 0.954 kilogram-meter, as graph that shown in Fig.3.

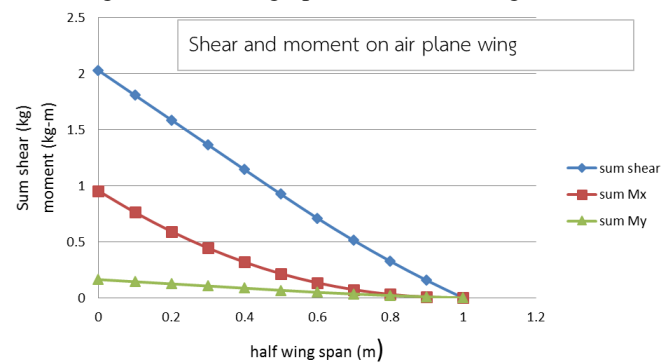

**Figure 3. Graph of Shear and Moment at various stages along the length of the wing.**

Next step is calculating the prototype with program XFLR5 which enables to analyze aerodynamics. Therefore, it can be read-out of the lift coefficient and then compare the values that obtained from the program XFLR5, as shown in Fig.4, with the values that calculated from the wing load distribution.

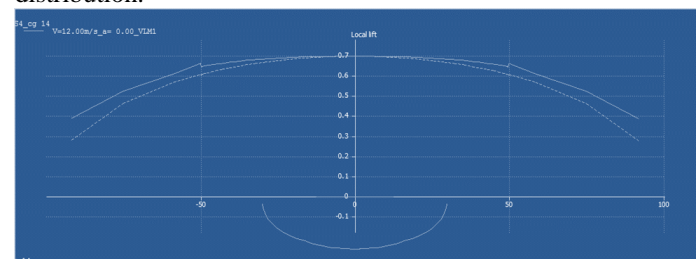

**Figure 4. The local lift distribution of XFLR5.**

Values from both methods are not equal as shown in Table 2. The lift force from program XFLR5 is greater than the value of theoretical calculations. So after comparison, values from the program XFLR5 was selected to use in wing testing cause it was greater than the other one and it has more safety factor.

## AME0001

**Table 2: Comparison of lift force from two methods.**

Distance along the length of wing (cm)	Lift from wing load distribution (kg)	Lift from programs XFLR5 (kg)
0	0.207	0.248
10	0.184	0.246
20	0.162	0.243
30	0.139	0.239
40	0.117	0.220
50	0.094	0.195
60	0.072	0.170
70	0.052	0.141
80	0.033	0.110
90	0.016	0.024
100	-	-

After analyzing the forces that occur to prototype, aircraft with a mechanism for wing strength testing was designed and built. To make sure that the wing can apply loads as calculated and do not be broken up while testing or operating flight in a real mission so carbon rods and spring locks are selected to use because of its strength and can easily found on the market. Starting from construction of the wing by using balsa and plywood. After the structure of the wing is complete, wing was installed with mechanical locking devices that designed to lock the carbon rod that attaches to the right and left wings to assemble them together. The locks are placed perpendicular to the axis of carbon rods due to the perpendicular position helped to prevent carbon rods sliding out cause of bending force. The carbon rods are mounted in line with the spar. Carbon rods were inserted into the core of center wing section, the locking latch is spring into hole on the carbon rods to fit the lock, as shown in Fig.5.

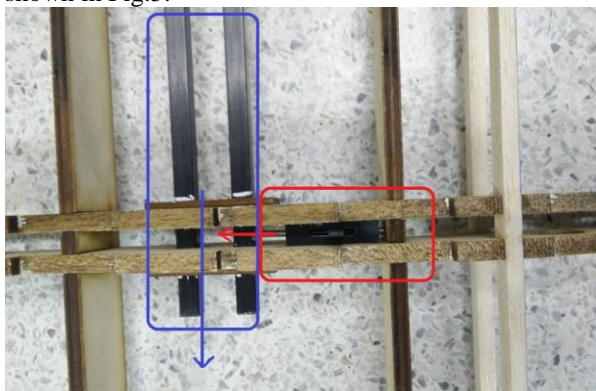

**Figure 5. The locked position of the carbon rods.**

In section of the fuselage structure have a mechanism at the rare of the body, as shown in Fig.6. In order to disassemble the tail boom (Carbon fiber tail boom) by carbon tube clumper, this section has tightening by nuts and bolts to fitting tail boom with clamp.

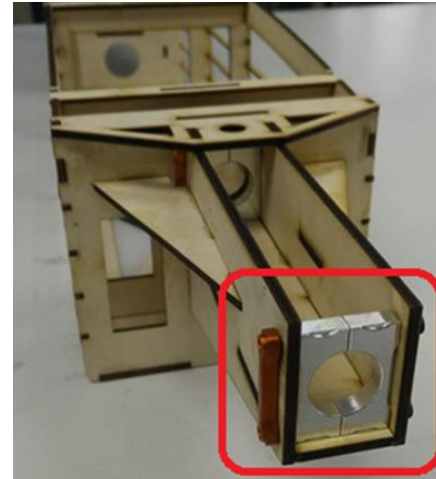

**Figure 6. Mechanism at the end of the fuselage.**

The last section is a section of the tail structure, which the middle area of the head and end of horizontal tail were carbon tube clumper that can locking mechanism in the same way as above. In the part of vertical tail, it can plug into the base of horizontal tail that has trench on the top and then locked up by a wood latch, as shown in Fig.7.

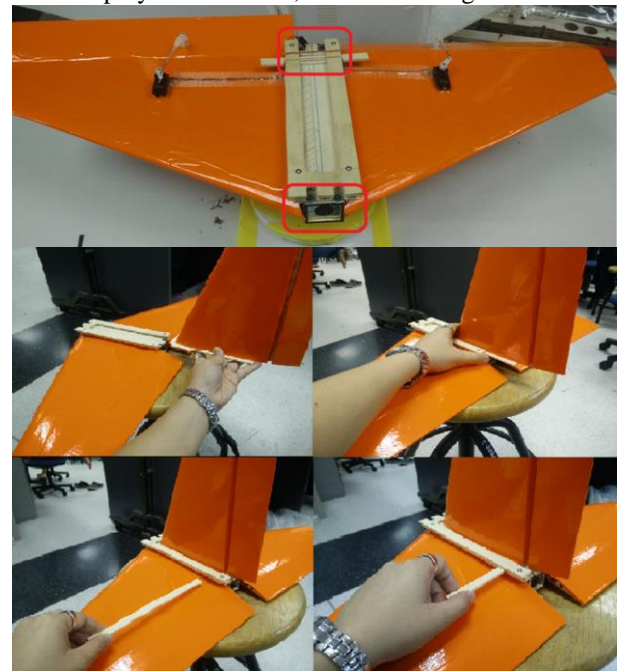

**Figure 7. The tail assembly process with a latch mechanism.**

#### 4. Wing testing, Flight test and Result

In part of wing testing, the wing was upside down, lower surface of wing became the top because lift force is pull the wing up in real flights, but the weight was put on lower surface in wing testing so the weight was load down. Therefore, from the load factor that equal to 2.5 [2, 5], wing structure was assumed as 1 time of weight then the weight of lift force in previous topic was multiplied by 1.5 times, as shown in Table 3.

## AME0001

**Table 3: Weight of wing testing with load factor.**

Distance along the length of wing (cm)	Cl	Testing weight (kg)	Testing weight with load factor (kg)
0	0.689	0.248	0.371
10	0.685	0.246	0.369
20	0.677	0.243	0.365
30	0.664	0.239	0.358
40	0.632	0.220	0.330
50	0.600	0.195	0.292
60	0.565	0.170	0.255
70	0.506	0.141	0.211
80	0.432	0.110	0.165
90	0.196	0.024	0.036
100	-	-	-

After that, weight with load factor was distributed on the wing by placing each weight from the wing root to wing tip, as shown in Fig.8.



**Figure 8. Characteristics of placing weight distribution on the wing.**

The test results showed that wing's structure and mechanical locking devices are strong enough to support force that occur. Locking mechanisms are also tight and do not make the wing fall apart from each other. The wing just has a little bended along the length of the wing and has some displacement from the original location, as a result of bending force.

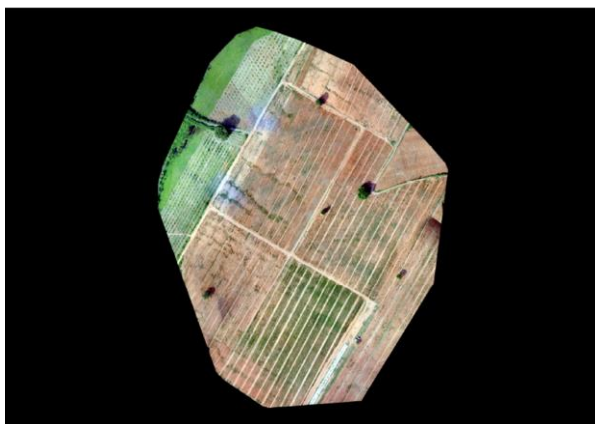

**Figure 9. Aerial photographs of Tapioca Development Institute (TTDI) at Huay Bong in Nakhon Ratchasima province.**

After the wing testing was completed, prototype was taken to the first flight testing that was flying to operate survey and mapping mission. From the first flight testing showed that prototype aircraft is effective in working and enable to fly to the performance requirements as high as 100 meters. Then the flight operations was made for survey and aerial photography, and have a product as a photomap of Tapioca Development Institute (TTDI) at Huay Bong, Korat, as shown in Fig.9.

### 5. Conclusion

From the studied, designed, and created mechanical locking devices for disassembly to a small unmanned aerial vehicle aircraft can concluded that locking devices enable to support weight or force that occur in three areas. Locking mechanisms at the wing can support the lifting force and have a function normally when it testing by increasing weight with load factor as 2.5 without damage to the mechanism and wing's structure. Locking devices at fuselage and tail can also support a force as well because they were attached with nuts and screws. This research can conclude that mechanical locking devices of three areas can be disassembled quickly and easily which made the research to complete the objectives. Although in wing testing still cannot conclude clearly that how much of forces will damage the mechanisms, due to testing until the break which is not in the budget and scope of this research.

### 6. Acknowledgement

The completion of this research could not have been without the grace and assistance of so many people whose names may not all be enumerated. The authors would like to express their deep appreciation and indebtedness to all of them.

Thank you, faculty of Aerospace Engineering, Kasetsart University to support in the experimental setup and testing.

### 7. References

- [1] Arthur, I. (2011). Fixed Wing UAV Modular Design and Development Summary. Part of a UNSW@ADFA project
- [2] Lieutenant, S.H. (2012). Fixed Wing Modular UAV Preliminary Structural Design. Final Project Report. UNSW@ADFA. 2012.
- [3] Michael, N.C. (1988). Airflame Structural Design, Conmilit Press Ltd, Hong Kong.
- [4] Wanabhumi, P. (2007). Spanwise Airload Distribution, Aerospace Engineering, Kasetsart University.
- [5] Zeus S.B. and Manuel N.D.B. Júnior.(2012). Structural design of MINI-UAVs with conventional and alternative materials. 14th Brazilian Congress of Thermal Sciences and Engineering, Rio de Janeiro, Brazil.