

BME0010

Development of 3-Milling Head CNC Machine for Insole Manufacturing

Pongpun Watasuntonpong^{1*}, Monsak Pimsarn¹, Chakarin Primdach¹ and Akapot Tantrapiwat¹

¹ Mechanical Engineering Department, Faculty of Engineering
King Mongkut's Institute of Technology Ladkrabang, Ladkrabang, Bangkok, Thailand, 10520
* Corresponding Author: p.watasuntonpong@gmail.com, +66987959368

Abstract

Currently, ulcerations on the plantar surface in the diabetic or foot tendon inflammation patients can be healed with non-surgical treatment using customized insoles. Nowadays, in Thailand, the customized insoles (CI) or orthotic footwear were manufactured by thermal vacuum forming method. In 2011 and 2014, Monsak and Pongpun proposed a custom-made insoles manufacturing [1,2] using the 1-milling head CNC machine to engrave CI. But this is still rather time-consuming. Thus, in this research, the 3-milling head CNC machine for insole manufacturing were proposed and developed. The developed machine consists of the in house CAM software and 3-milling head CNC machine. The 3-milling head tools can be simultaneously operated or can be chosen for 1, 2 or 3-milling head at a time. In order to justify the efficacy of 3-milling head CNC machine, two study cases are experimentally carried out. First, the three simple models were manufactured using the 3-milling head CNC machine and 1-milling head tool. After that, the dimensions of milled models were compared and it was found that they were in good agreement. In the last study case, using the 3-milling and 1-milling head CNC machines, the CIs were manufactured to compare the manufacturing time and the dimensions. The obtained results indicated that the 3-milling head CNC machine can decrease the manufacturing time and the dimension data of workpieces were in good agreement.

Keywords: custom-made insoles, orthotic footwear, CNC machine

1. Introduction

Diabetes mellitus (DM) or Diabetic is a global health problem, resulting in major health resultant for the diabetic patient and the economics of the society [3]. In the globe, the total number of DM patients found is approximately 370 million and there are about 280 million patients who are in risky condition. It is predicted by year 2030 will increase to 500 million [4]. In Thailand, the number of diabetic patients is 3.5 million in 2009 and will increase to 4.7 million by 2017 [5]. 7749 Diabetic patients died in 2012 i.e., 22 people per day in average [6]. The foot ulceration are important complications of lower-limb amputations of diabetic patients [7, 8]. It is caused by peripheral sensory neuropathy. Neuropathic diabetic foot ulceration can be prevent if the plantar stress transmitted from ultimate stress point to all plantar tissues is reduced by offloading prevention [9]. The orthosis insole therapy is one of the practical methods to reduce high plantar stress and ulceration risk. The orthosis insoles must conform to individual foot shape. CIs were produced to match between foot surfaces and insole surface.

The production of CI has been established and proposed for many years using different techniques. Nowadays, in Thailand, CI is conventionally produced by the skilled medical physician in health care systems. The manufacturing processes of CI are in form of the traditional plaster casting mold and the thermal vacuum forming techniques, which produces wastes from plaster. In 2007, the scanning foot technique and CAD/CAM (computer-aided design and computer-aided

manufacturing) system were introduced in the manufacture of CI [10].

This paper presents the development of 3-milling head CNC machine for insole manufacturing. The aim of this study is to develop the manufacturing of CI in the part of CNC machine. Normally, a CNC machine was used to engrave the material (EVA foam, polymer) and the machine, in general, has only one milling head. The CI production time is rather slow. Therefore, this paper proposes the 3-milling head CNC machine system which can engrave workpieces simultaneously with 3-milling head toolpath. It is expected that this system can accelerate the production rate and yield the same quality of product with 1-milling head toolpath.

2. Methodology

The 3-milling head CNC machine was developed to produce the customized insoles. This research is a part of the developed insole production system in diabetic patients which consist the novel method of foot sole surface impression machine (developed by Monsak, Pongpun [1, 2]) and the developed 3-milling head CNC machine.

This 3-milling head CNC machine consisted hardware and software. The hardware is the 3-milling head CNC machine. The software is the in house 3-head CAM software.

2.1 The 3-milling head CNC machine

The 3-milling head CNC machine (shown picture in Figure 1) was developed to produce the alternative customized insole manufacturing methodology. The

BME0010

working area of CNC machine is 400*400*150 mm in X Y and Z axis, respectively. It has maximum feed rate 1600 mm/min which drive the ball screw and ball nut by the step motor. This machine uses the 100VDC 500W spindle motor which has air cooling system, maximum torque 0.55 NM, maximum speed 12,000 RPM. The each spindles of toolpath can set the rotational speed. It supports the maximum ER11 collet 6 mm which uses the clamping system. It can use a milling cutter such as the end mill cutter and the ball nose cutter. The 3-milling head CNC machine was operated by a sample materials (ethylene vinyl acetate foam, expanded polystyrene foam) and was designed in the basic of 3 axis CNC machine which contain X Y and Z axis coordinate system. The X Y axis coordinate moves in the horizontal axis system. The Z axis coordinate move in the vertical axis system. But the 3-milling head CNC machine was differed from the other 3 axis CNC machine.

Normally, the 3 axis CNC machine has only one vertical axis movement in Z axis coordinate and has only one head milling toolpath but the new 3-milling head CNC machine has 3 vertical axis movement in Z A B axis coordinate (shown picture in Figure 2) and has 3 head milling toolpath. In the operation time, all 3-milling head toolpath axis can move up-down independently in each vertical axis. The milling head toolpath can move simultaneously in 3-vertical axis coordinate. The mach3 is controller software which operates by PC computer. The mach3 software was used to control this CNC machine. It costs cheap and simple to operate the machine which is famously software of the developer of mini CNC machine. The NEMA 23 2.8A stepping motor was used to drive the axis coordinate operated by the controller board system (TB6600 5A board).

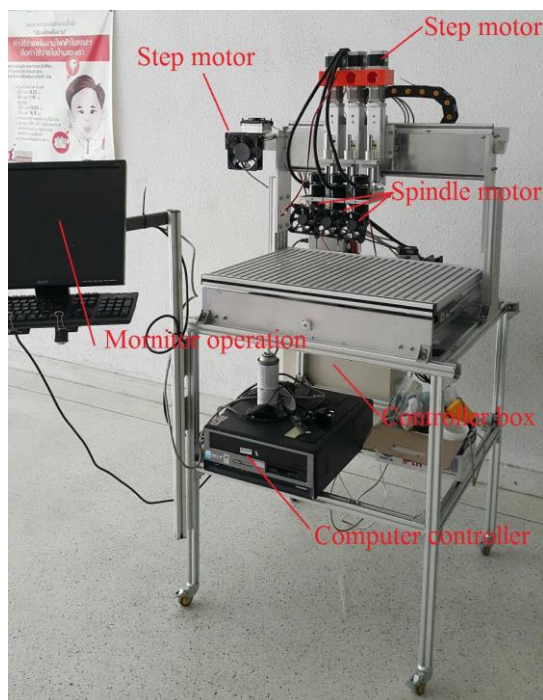

Fig. 1 The 3 head milling CNC machine

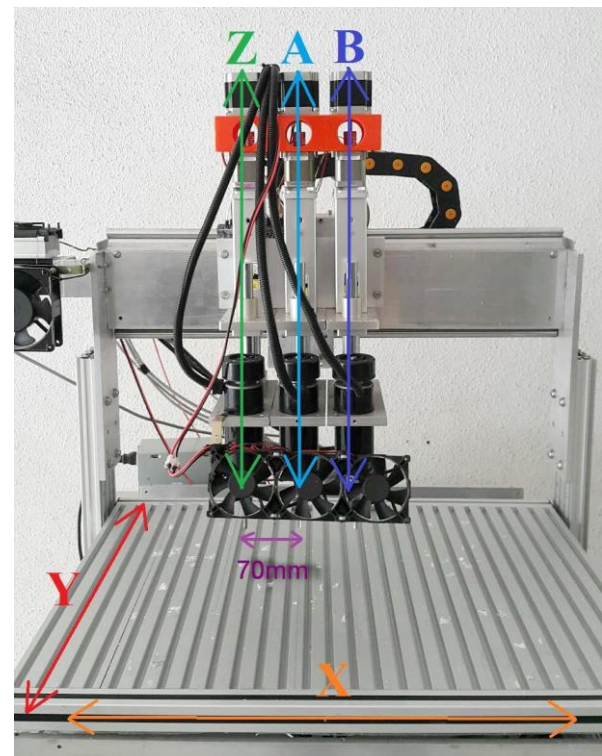

Fig. 2 The axes of 3 head milling CNC machine

2.2 The in house 3 head CAM software

The in house 3 head CAM software is computer aided manufacturing software (CAM), as shown in Figure 3. This CAM software was developed for using with the specific 3 head milling CNC machine and was designed in the basic milling CAM software. It uses to produce the customized insoles. The software was designed to calculate the toolpath manufacture from the CAD (computer aided design) model file or insole model file in .STL (Stereolithography) format. The in house 3 head CAM software can assign the function parameter of CAM which consist Geometry, Tool, Levels, Technology. Geometry bar can choose the origin point of model and shows size of model. Tools bar can choose a number of toolpath which has 1-3 milling head toolpath which can define the size of tool diameter, tool pitch and feed rate of X Y Z axis coordinate. Levels bar shows the size of part upper/lower and clearance level. Technology bar can define the size of step down and overlap which can choose the cutting direction (Zigzag or One way). Create G-code bar was selected. The software will automatically divide the working area of the CAD model for the 3-milling head toolpath in 3 section or more than. If the all divided working area had more than the selection toolpath area (as shown in Figure 4) and can define the distance of each milling toolpath which differed from normal CAM software (only one toolpath). That was shown the functional environment of in house 3 head CAM software screen in Figure 5.

Finally, the in house 3 head CAM software will generate the G-code (a programming language for

BME0010

numerical control). It was used mainly to control the 3-milling head CNC machine.

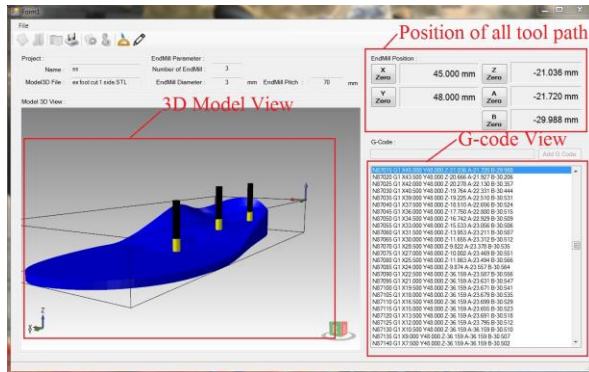

BME0010

3. Result

The effectiveness of the 3 head milling CNC machine was studied by comparing the dimension of milled model data which obtained from the 3 head CAM software and SolidCAM software. These dimension data (M, N, C, D, E, F, G, H, I and J as shown in Figure 8) were measured using the vernier caliper and the protractor for angular. The example models were produced 3 pieces for each process which have 6 pieces. The process were the milled model which generated by the in house 3 head CAM software and SolidCAM. Figure 9 shows the 3-milling head CNC machine which engraved the EPS foam to the example model. Figure 10 shows the milled model which was manufactured from the SolidCAM software. Figure 11 shows the milled model which was manufactured from the in house 3 head CAM software. All CAM design set the same condition which consist the x y z feed rate 1000 mm/min , 2 teeth M-milling toolpath diameter 6 mm, pitch distance is 1 mm, maximum speed of all spindle motor and cutting direction is Zigzag. The pitch distance of each vertical axis system (Z, A, B axis) is 70 mm which fix condition. The results of measured example data were shown in Table 1 and the time of milling production were shown in Table 2. The experiment result showed the average dimension of the manufactured models, which have 3 pieces for each process and total have 6 pieces, were not much different from the example CAD file. Therefore, this milled model from G-code of the in house 3 head CAM software yields equivalent the dimension data to the milled model from G-code generated by SolidCAM software.

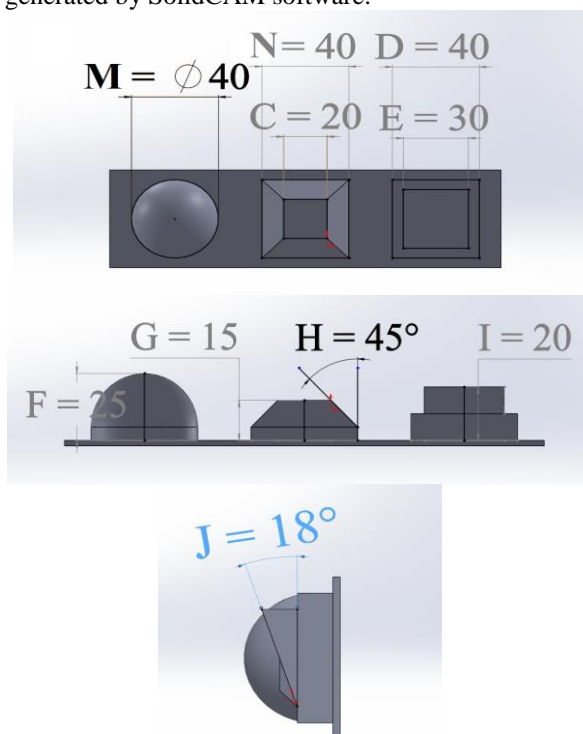

Fig. 8 The dimension data M, N, C, D, E, F, G, H, I and J

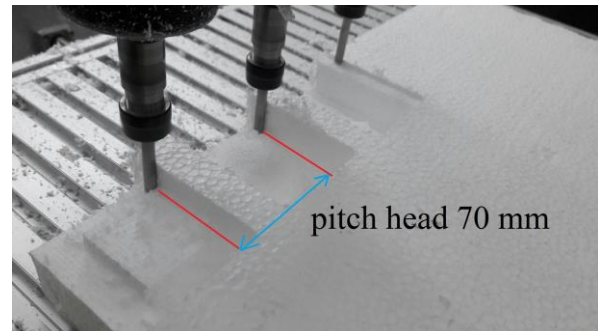

Fig. 9 The 3-milling head CNC machine engraved the EPS foam to the example model.

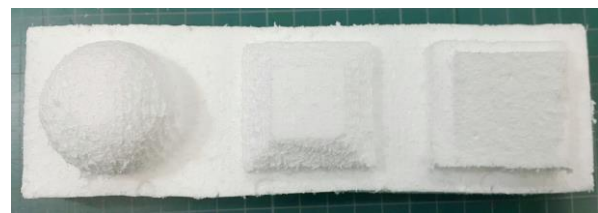

Fig. 10 The example models were manufactured from SolidCAM software.

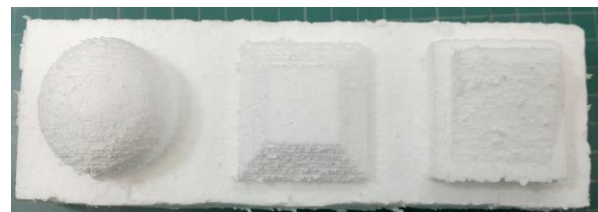

Fig. 11 The example models were manufactured from the in house 3 head CAM software.

Table. 1 The average of measured data obtained from 1-head CNC machine and 3-head CNC machine

Dimension position	3D Model (mm)	1-head CNC(mm)	3-head CNC(mm)
M	40	40.2	40.2
N	40	40.3	40.1
C	20	20.6	20.5
D	40	40.1	39.8
E	30	30	29.9
F	25	25	25
G	15	15	15
I	20	19.8	19.5
H (degree)	45	45	45
J (degree)	18	18	18

Table. 2 The time of milling production from 1-head CNC machine and 3-head CNC machine

1-head CNC (minute)	No.1	No.2	No.3	Average
	55	55	55	55
3-head CNC (minute)	No.1	No.2	No.3	Average
	25	25	25	25

BME0010

4. Discussion and conclusion

The 3-milling head CNC machine and the in house 3 head CAM software are a novel method for the personalized manufacture of customized insoles. The effectiveness of the 3-milling head CNC machine was studied by comparing the dimension of milled model data which obtained from SolidCAM software and the in house 3 head CAM software. The experimental result showed the average dimension of the milled models, which have 3 pieces for each process, were not much different from the data of example CAD file. The process has used the 3-milling head toolpath for manufacturing the example model which generated G-code by the in house 3 head CAM software. The working area was divided in 3 section area. It used 25 minutes which was faster than the example model generated G-code by SolidCAM software which has only 1 section of working area. It used 55 minutes. For the testing manufacture, the customized insoles used with this process. The example of customized insole CAD file was design by SolidWork software, as shown in Figure 12. Figure 13 shows the 3-milling head CNC machine engraved the EPS foam to the customized insole. The manufacture set the same condition with the example model condition. It consist the x y z feed rate 1000 mm/min, pitch distance is 1 mm, 2 teeth M-milling toolpath diameter 6 mm, maximum speed of all spindle motor and the cutting direction is Zigzag. The pitch distance of each vertical axis system (Z, A, B axis) is 70 mm. In this process, the working area was divided in 4 section area. At the 1, 2 and 3 section area which the milling head toolpath have worked together at the same time but the section number 4 has later engraved by only the Z axis toolpath after the 1-3 section area has finished. Figure 14 shows the customized insole manufacture from the SolidCAM software which had only 1 section working area and used 120 minutes to engrave. Figure 15 shows the customized insole manufacture from the 3 head CAM software which used 70 minutes to engrave.

The production time of example model which engraved by the selected 3 milling head toolpath was faster than the another process because the total working area was divided in 3 section or more than for each milling toolpath and all milling head toolpath have worked together at the same time. It is different from another process which has only 1-milling head toolpath and 1 working area.

However, the in house 3 head CAM software and the 3-milling head CNC machine are the beginning software and the prototype CNC machine which have many thing to develop process such as the algorithm of generate G-code, the mechanical design of CNC machine and the new technique for manufacturing process. Thus, the research need to develop and experiment this system more efficient to replace the commercial software and CNC machine.

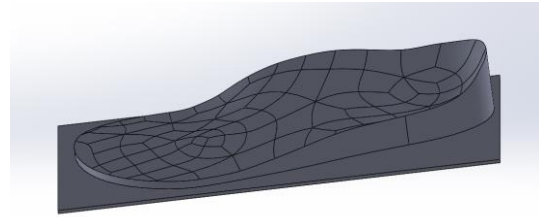

Fig. 12 The customized insole CAD file was made by SolidWork software

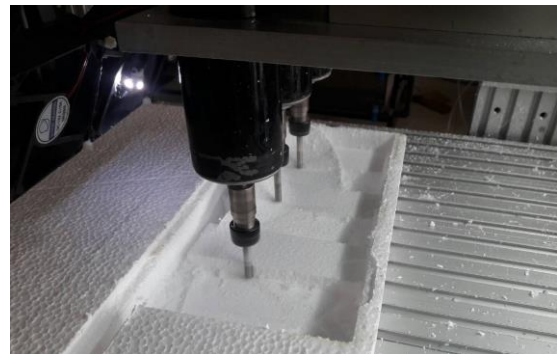

Fig. 13 The 3-milling head CNC machine engraved the EPS foam to the customized insole



Fig.14 The customized insole was engraved by using the 1 milling head toolpath.



Fig.15 The customized insole was engraved by using the 3-milling head toolpath.

5. Acknowledgements

In this work the authors deeply impression and thank the mechanical department of King Mongkut's Institute of Technology Ladkrabang for valuable support by offering tools and grants.

BME0010

6. References

- [1] Monsak Pimsarn, Pongpun W.: Novel method of foot sole surface generation for insole manufacturing, ME-NETT 25th, 2011
- [2] Monsak Pimsarn, Pongpun W.: Effectiveness of milled-insole in plantar pressure reduction, TSME-ICOME 5th, 2014
- [3] Wild S, Roglic G, Green A, Sicree R, King H. Global prevalence of diabetes: estimates for the year 2000 and projections for 2030. *Diabetes Care*. 2004; **27**(5):1047-53.
- [4] Huang ES, Basu A, O'Grady M, Capretta JC. Projecting the future diabetes population size and related costs for the U.S. *Diabetes Care*;2009,Vol.32, p.2225–2229
- [5] News: World Diabetes
Day <http://www.komchadluek.net/detail/20131030/171670.html>
- [6] Weeagul P, Worawat S. The Prototype of Computer-Assisted for Screening and Identifying Severity of Diabetic Retinopathy Automatically from Color Fundus Images for mHealth System in Thailand: iEECON2016, 2-4 March 2016, Procedia Computer Science 86 (2016) 457 – 460
- [7] Pecoraro, P., Reiber, G., & Burgess, E. M. (1990). Pathways to diabetic limb amputation. Basis for prevention. *Diabetes Care*, 13(5), 513–521.
- [8] D Malgrange, JL Richard, Screening diabetic patients at risk for foot ulceration. A multi-centre hospital-based study in France, *Diabetes & Metabolism* Volume 29, Issue 3, June 2003, Pages 261-268
- [9] Kato, H., Takada, T., Kawamura, T., Hotta, N., Torii, S., 1996. The reduction and redistribution of plantar pressures using foot orthoses in diabetic patients. *Diabetes Res.Clin. Pract.* 31 (1–3), 115–118.
- [10] Parreno E M. Advanced tools for the design and sale of customized footwear: case studies. In: *The 2007 world conference on mass customization & personalization (MCP)*. Cambridge, MA: Massachusetts Institute of Technology (MIT); 2007.